



2SD313

NPN EPITAXIAL SILICON TRANSISTOR

LOW FREQUENCY POWER AMPLIFIER

- Complement to 2SB507

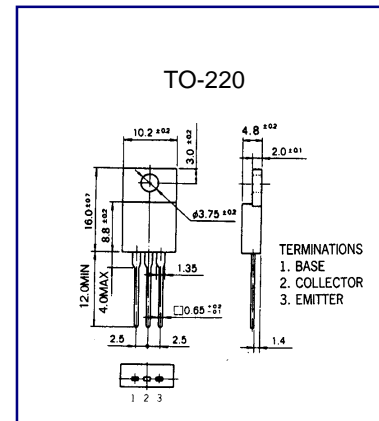

ABSOLUTE MAXIMUM RATINGS ($T_A=25^\circ\text{C}$)

Characteristic	Symbol	Rating	Unit
Collector-Base Voltage	V_{CB0}	60	V
Collector-Emitter Voltage	V_{CE0}	60	V
Emitter-Base voltage	V_{EB0}	7	V
Collector Current (DC)	I_C	3	A
Collector Dissipation ($T_c=25^\circ\text{C}$)	P_C	30	W
Junction Temperature	T_j	150	$^\circ\text{C}$
Storage Temperature	T_{stg}	-50~150	$^\circ\text{C}$

ELECTRICAL CHARACTERISTICS ($T_A=25^\circ\text{C}$)

Characteristic	Symbol	Test Condition	Min	Typ	Max	Unit
Collector Cutoff Current	I_{CBO}	$V_{CB}=60\text{V}, I_E=0$			100	μA
Emitter Cutoff Current	I_{EBO}	$V_{EB}=7\text{V}, I_C=0$			100	μA
DC Current Gain	h_{FE1}	$V_{CE}=2\text{V}, I_C=1\text{A}$	40		320	
Collector- Emitter Saturation Voltage	$V_{CE(sat)}$	$I_C=2\text{A}, I_B=0.2\text{A}$			1.0	V
Current Gain Bandwidth Product	f_T	$V_{CE}=5\text{V}, I_C=0.5\text{A}$		8		MHZ